

LED Stadium Eyes Light Series

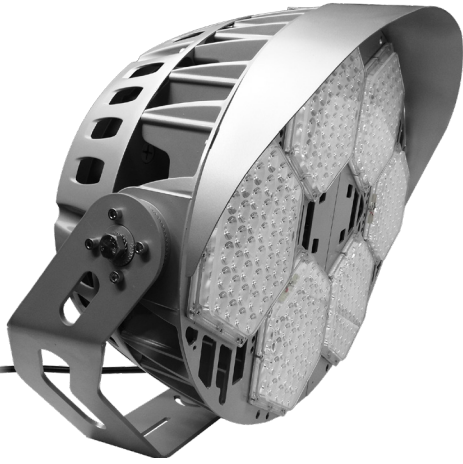

Wattages: 400W, 600W



The Stadium Eyes LED Lighting Series can be widely used for Indoor or Outdoor (Wet Location) Excellent for Large outdoor fields -stadiums, riding arenas, baseball and football fields, Other large outdoor areas: parks, docks, shipyard, airport and many other applications.



FEATURES

- LED high luminous efficiency and long working life.
- High efficiency LED Driver, the wide range input voltage AC120-277V / 277-480V.
- Die-cast aluminum cooling design, high quality and better cooling for LED Tj < 85°C.
- Excellent optics design, greatly improve the light utilization and evenness.
- 12V auxiliary dimming/Dali dimming (Optional)

LIGHTING ANGLE

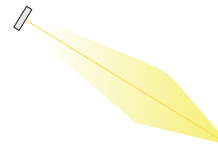

NEMA III

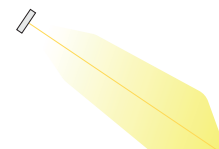

NEMA IV



NEMA V

| SPECIFICATION | | |
|------------------------|---------------------------------|----------|
| WATTAGE | 400W | 600W |
| LUMEN | 56800 lm | 85200 lm |
| EFFICACY | 140 lm/W | 140 lm/W |
| CCT | 4000K, 5000K | |
| CRI | 80 | |
| INPUT VOLTAGE | AC120-277V / 277-480V | |
| LIGHTING ANGLE | NEMA III, IV, V | |
| FIELD ANGLE (10% LMAX) | 39.6 (III), 55.1 (IV), 84.8 (V) | |
| BEAM ANGLE (50% LAMX) | 20.5 (III), 30.0 (IV), 53.5 (V) | |
| POWER FACTOR | 0.95 | |
| DRIVER EFFICACY | 92% | |
| DIMMING | 12V auxiliary dimming | |
| LIFE SPAN | up to 75,000 hrs | |
| WORKING TEMPERATURE | -22°F ~ 113°F | |
| STORAGE TEMPERATURE | -40°F ~ 176°F | |
| OUTDOOR RATING | Wet location | |
| CABLE | 3core, 16AWG (1.0m) | |
| WARRANTY | 5 year limited | |

LED Stadium Eyes Light Series

Wattages: 400W, 600W

DIMENSION

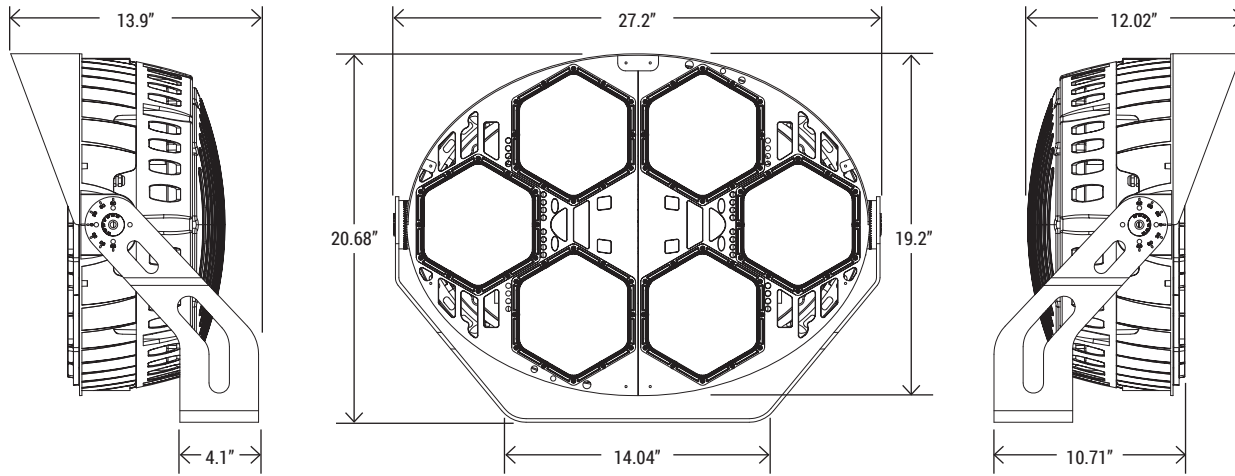

| | | |
|------------|---------------------|----------|
| EPA | 2.3 ft ² | |
| NET WEIGHT | 49.6 lbs | 51.8 lbs |

BOX DIMENSION : 31.1" x 28.3" x 11.4"

ELECTRICAL LOAD

| WATTAGE | CURRENT (VOLTAGE) (AMP) | | | | | |
|-----------|-------------------------|----------|---------|----------|----------|----------|
| | 120V | 208V | 240V | 277V | 347V | 480V |
| WSD-SE40W | 3.33 Amp | 1.92 Amp | 1.6 Amp | 1.44 Amp | 1.15 Amp | 0.83 Amp |
| WSD-SE60W | 5.0 Amp | 2.8 Amp | 2.5 Amp | 2.16 Amp | 1.72 Amp | 1.25 Amp |

ORDERING INFORMATION

EXAMPLE:

WSD-SE40W27-XXK-Z[D, W, B, S]-NM[N3,N4,N5] U[S, A, T]-G[BLANK, L]-F[BLANK, SPD]

| WSD | SE | 40W | 27 | YYK | Z | NM | U | G | F |
|-------------|--------------------------------------|------------------------------|------------------------------------------|--------------------------------|--------------------------------------------------------------------|----------------------------------------------------|-------------------------------------------------|------------------------------------------|---------------------------------------|
| COMPANY | PRODUCT | WATTAGE | VOLTAGE | CCT | FINISH | LIGHT ANGLE | MOUNTING | CONTROL | SAFETY DEVICE |
| WSD LED INC | SE (Stadium Eyes Light Series) | 40W - (400W) 60W - (600W) | 27 (AC120-277V) 48 (AC277-480V) | 40K - (4000K) 50K - (5000K) | D - (Dark Bronze) W - (White) B - (Black) S - (Silver) | N3 - (Nema III) N4 - (Nema IV) N5 - (Nema V) | S - (Slipfitter) A - (Arm) T - (Trunnion) | L - (Wireless Lighting Controller) | SPD - (Surge Protection Device) |

LED Stadium Eyes Light Series

Wattages: 400W, 600W

PHOTOMETRICS

For complete IES files, please visit our website.

WSD-SE40W27-50K-D-N3

LUMINOUS INTENSITY DISTRIBUTION DIAGRAM

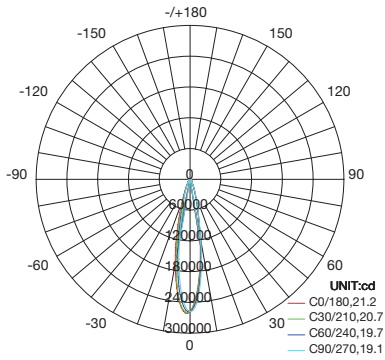

AVERAGE BEAM ANGLE(50%):20.2 DEG

C0 PLANE ISOLUX DIAGRAM (UNIT:lx)

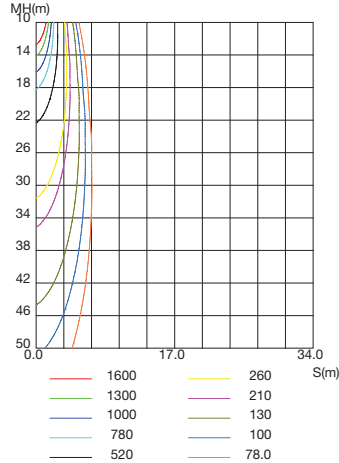

WSD-SE40W27-50K-D-N4

LUMINOUS INTENSITY DISTRIBUTION DIAGRAM

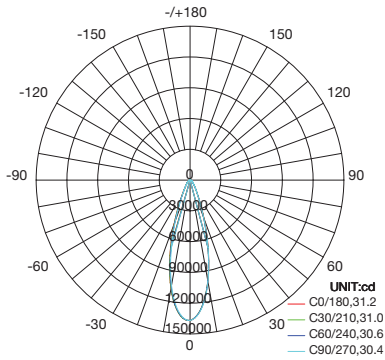

AVERAGE BEAM ANGLE(50%):30.8 DEG

C0 PLANE ISOLUX DIAGRAM (UNIT:lx)

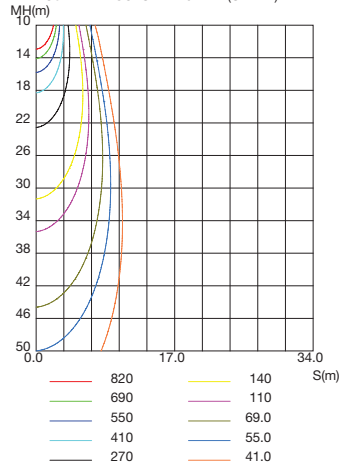

WSD-SE40W27-50K-D-N5

LUMINOUS INTENSITY DISTRIBUTION DIAGRAM

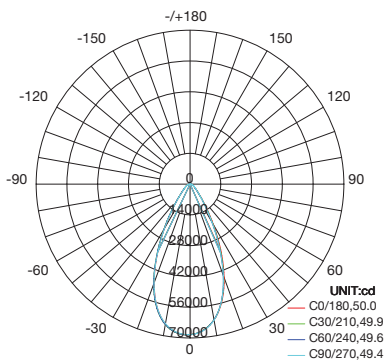

AVERAGE BEAM ANGLE(50%):49.7 DEG

C0 PLANE ISOLUX DIAGRAM (UNIT:lx)

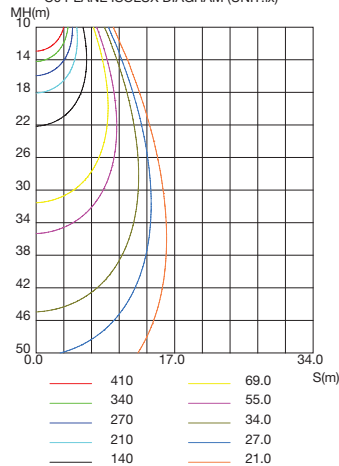

LED Stadium Eyes Light Series

Wattages: 400W, 600W

CONTROLS (SOLD SEPARATELY)

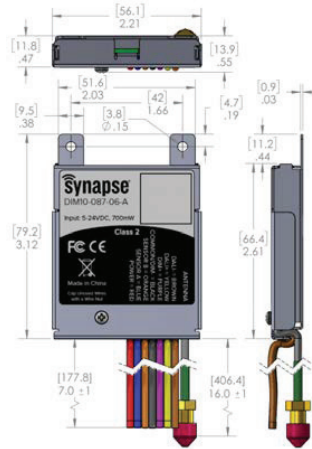
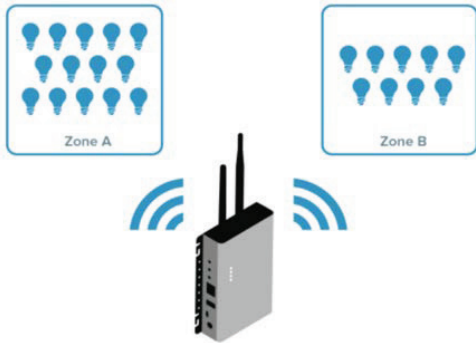

DALI-2/DIM TO OFF WIRELESS LIGHTING CONTROLLER

DIM10-087-06-A

| | |
|---------------------|----------------------------------------------------------------------------|
| INPUT | 5 to 24V DC, 700 mW max |
| DALI-2 | Limited to 8 LED Drivers |
| SENSOR INPUT | Analog: 0-10V / Digital: 0-24V |
| IP RATING | IP30 |
| DIMMING | 0-10V, 10 mA (Max) |
| WORKING TEMPERATURE | -40°F ~ 185°F |
| RADIO | SNAP 2.4GHz ; 802.15.4 +20 dBm Transmit Power -103 dBm Receive Sensitivity |
| WIRE SIZE | 20 AWG, 6" Wires, 600V |
| CERTIFICATIONS | UL Recognized Component; CE; FCC/ IC; Indoor/Outdoor |
| WARRANTY | 5 year limited |

WIRING DIAGRAM

